

User Guide

INSIGNIA™



iPod® is a registered trademark of Apple Computers

CD Shelf System with iPod® Dock

NS-ES6113

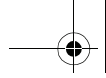

INSIGNIA™

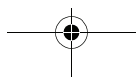
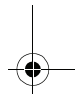
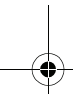
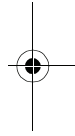
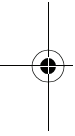



Insignia NS-ES6113 CD Shelf System with iPod® Dock

Contents

Introduction	3
Safety information	3
Features	7
Setting up your shelf system	12
Using your shelf system	15
Troubleshooting	24
Maintaining	25
Specifications	25
Legal notices	26
One-year limited warranty	27

Introduction

Congratulations on your purchase of a high-quality Insignia product. Your NS-ES6113 represents the state of the art in shelf system design and is designed for reliable and trouble-free performance. Your shelf system also includes an iPod® dock that lets you play iPod® songs through your shelf system speakers.

Safety information



	The lightning flash with arrowhead symbol within an equilateral triangle is intended to alert you to the presence of uninsulated dangerous voltage within your shelf system's enclosure that may be of sufficient magnitude to constitute a risk of electric shock.
--	---

	The exclamation point within an equilateral triangle is intended to alert you to the presence of important operating and maintenance (servicing) instructions in the literature accompanying your shelf system.
--	---

INSIGNIA™ Insignia NS-ES6113 CD Shelf System with iPod® Dock

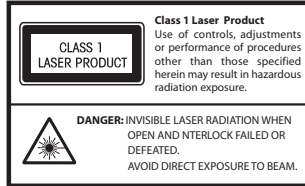

Caution - laser warning

This product employs a laser system. To ensure correct use of this product, read this owner's manual carefully and retain it for future reference. Should your player require maintenance, contact qualified service personnel.

- 1) Read these instructions.
- 2) Keep these instructions.
- 3) Heed all warnings.
- 4) Follow all instructions.
- 5) Do not use this apparatus near water.
- 6) Clean only with dry cloth.
- 7) Do not block any ventilation openings. Install in accordance with the manufacturer's instructions.
- 8) Do not install near any heat source, such as radiators, heat registers, stoves, or other apparatus (including amplifiers) that produce heat.
- 9) Do not defeat the safety feature of the polarized or grounding-type plug. A polarized plug has two blades and a third grounding prong. The wide blade or the third prong are provided for your safety. If the provided plug does not fit into your outlet. Consult an electrician for replacement of the obsolete outlet.
- 10) Protect the power cord from being walked on or pinched, particularly at plugs, convenience receptacles, and the point where they exit the shelf system.
- 11) Only use attachments/accessories specified by the manufacturer.
- 12) Use only with the cart, stand, tripod, bracket, or table specified by the manufacturer, or sold with the apparatus. When a cart is used, use caution when moving the cart/apparatus combination to avoid injury from tip-over.
- 13) Unplug this shelf system during lightning storms or when unused for long periods of time.

PORTABLE CART WARNING
(Symbol provided by RETAC)



14) Refer all servicing to qualified service personal. Servicing is required when the shelf system has been damaged in any way, such as the power cord or plug is damaged, liquid has been spilled or objects have fallen into the shelf system, the shelf system has been exposed to rain or moisture, does not operate normally, or has been dropped.

15) Do not expose your shelf system to dripping or splashing liquids, and no objects filled with liquids should be placed on it.

16) Excessive sound pressure from earphones and headphones can cause hearing loss.

17) The AC adapter is used as the disconnect device and it shall remain readily operable during use. In order to disconnect the shelf system, the AC adapter should be removed from the AC power outlet completely.

18) The batteries (battery pack and batteries installed) shall not be exposed to excessive heat, such as sunshine, fire, or similar heat sources.

Caution - proper installation

- Install the system in a place which is level, dry, and neither too hot nor too cold. The appropriate temperature is between 41° F and 95° F (5° C and 35° C).
- Install the system in a location with adequate ventilation to prevent internal heat from building up inside the unit.
- Leave sufficient distance between the system and your TV.
- Keep the system away from your TV to avoid interference.

INSIGNIA™ Insignia NS-ES6113 CD Shelf System with iPod® Dock

Caution - proper ventilation

To avoid risk of electric shock and fire, and to prevent damage, locate the apparatus as follows:

- **Front:** No obstructions and open spacing.
- **Sides/Top/Back:** No obstructions should be placed in the areas shown by the dimensions below.

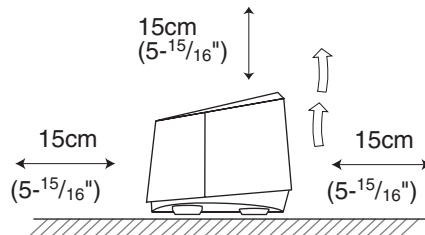
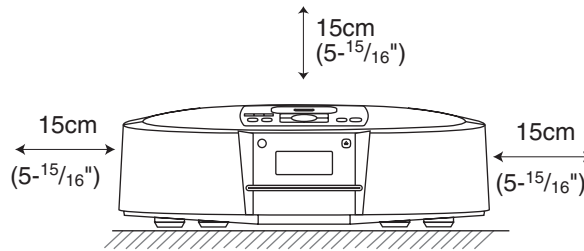

- **Bottom:** Place on the level surface. Maintain an adequate air path for ventilation by placing on a stand with a height of 10 cm (3-15/16") or more.

Note

Read Rating Labels on the bottom of the system for power input and other safety information.

Disposal of old equipment

[European Union] This symbol indicates that the electrical and electronic equipment should not be disposed as general household waste at its end-of-life. Instead, the product should be handed over to the applicable collection point for the recycling in accordance with your national legislation.



By disposing of this product correctly, you will help to conserve natural resources and will help prevent potential negative effects on the environment and human health that could otherwise be caused by inappropriate waste handling of this product. For more information about collection point and recycling of this product, please contact your local municipal office, your household waste disposal service or the shop where you purchased the product.

Penalties may be applicable for incorrect disposal of this waste, in accordance with national legislation.

[Other Countries outside the European Union]

If you wish to dispose of this product, please do so in accordance with applicable national legislation or other rules in your country for the treatment of old electrical and electronic equipment.

Features

Package contents

Your shelf system includes the following items:

- Main shelf system unit
- Remote control with CR2025 lithium coin battery
- AC adapter
- AM loop antenna
- *User Guide*
- iPod® dock adapters (6)

LCD display

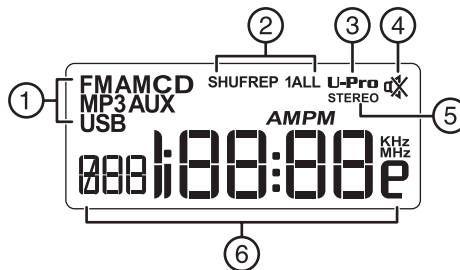

#	Information
1	Current sound source (FM/AM/CD/MP3/AUX/USB)
2	Lights when repeat (REP 1 or REP ALL) or shuffle play (SHUF) mode is selected.
3	U-Pro icon. Lights when U-Pro (High Definition Wide Stereo) sound effect is activated.
4	Mute icon. Lights when the sound is muted.
5	Stereo icon. Lights when FM stereo is selected.
6	Multi-function display. Indicates iPod® source, or track number, volume level, channel, radio frequency, or current time.

INSIGNIA™ Insignia NS-ES6113 CD Shelf System with iPod® Dock

Front panel

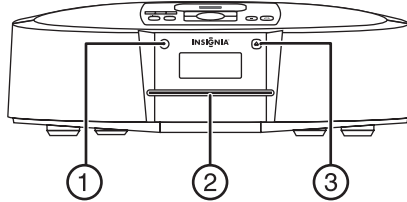

#	Component	Description
1	IR sensor	Receives the signal from the remote control.
2	CD slot	Place the CD in this slot with the label facing up.
3	 (eject)	Press to eject the CD.

Back panel

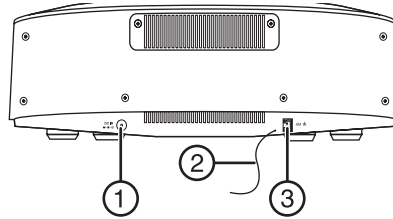

#	Component	Description
1	DC IN jack	Connect the AC adapter to this jack.
2	FM antenna	Use to receive FM signals.
3	AM antenna jack	Connect the AM loop antenna to this jack.

Top panel

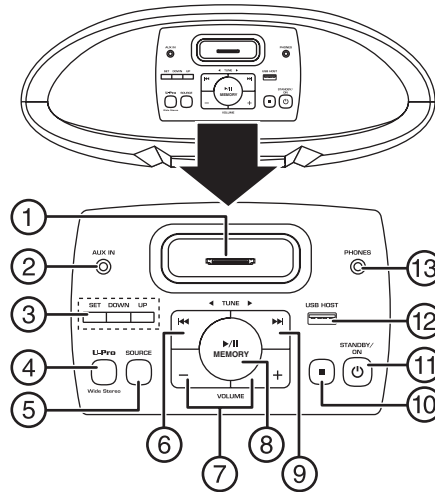

#	Component	Description
1	iPod® dock	Place your iPod® here to connect it to the shelf system.
2	AUX IN jack	Plug the cable from an external sound source into this jack.
3	Clock setting buttons	Press to set the clock on the LCD. See “Setting the clock” on page 15. In tuner mode, press UP or DOWN buttons to directly select preset stations.
4	U-Pro Wide Stereo button	Press to activate U-Pro (High Definition Wide Stereo) sound effects. Press again to deactivate U-Pro sound effects.
5	SOURCE button	Press to cycle through the available sound sources, including CD , iPod® , Tuner , USB , and AUX . The current choice is shown on the LCD.
6	◀◀ (previous) button	In CD, iPod®, or USB mode, press to go to the previous track. Hold the button in to fast reverse a track. In tuner mode, press to seek the previous (lower frequency) radio station.
7	VOLUME -/+ buttons	Press to decrease (-) or increase (+) the volume.

INSIGNIA™ Insignia NS-ES6113 CD Shelf System with iPod® Dock

#	Component	Description
8	▶ (play/pause)/ MEMORY button	In playback mode, press to begin playback. Press again to pause playback. Press again to resume playback. In tuner mode, press and hold to save a station.
9	▶▶ (next) button	In CD, iPod®, or USB mode, press to go to the next track. Hold the button in to fast forward a track. In tuner mode, press to seek the next (higher frequency) radio station.
10	■ STOP button	In CD or USB mode, press to stop playback. In iPod® mode, press to pause playback.
11	⏻ STANDBY/ON button	Press to turn your shelf system on. Press again to put your shelf system in standby mode.
12	USB HOST jack	Plug a USB device into this jack.
13	PHONES jack	Connect your headphone plug to this jack.

Remote control

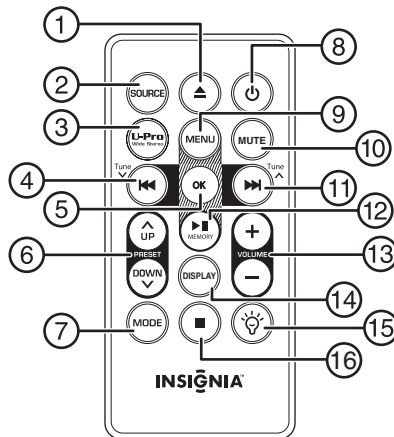

#	Button	Description
1	▲ EJECT	Press to eject the CD.
2	SOURCE button	Press to cycle through the available sound sources, including CD , iPod® , Tuner , USB , and AUX . The current choice is shown on the LCD.

#	Button	Description
3	U-Pro Wide Stereo button	Press to activate U-Pro (High Definition Wide Stereo) sound effects. Press again to deactivate U-Pro sound effects.
4	◀◀ (previous)/TUNE ▼ button	In CD, iPod®, or USB mode, press to go to the previous track. Hold the button in to fast reverse a track. In tuner mode, press to seek the previous (lower frequency) radio station.
5	OK button	Press to confirm the selected item when your iPod® is operated in the iPod® dock. You can directly use the remote control to operate the iPod's playback and setting by watching the iPod's display. If your disk or USB device contains more than one track, you can press to select a specific track (in stop mode) for playback, press PRESET UP or DOWN to select the track, then press OK again to play it.
6	PRESET UP ▲/DOWN ▼ buttons	In tuner mode, press to go the next or previous radio preset. In iPod® mode, press to move the cursor up or down on the iPod® display. In CD or USB mode, press to enter a specific track number for play.
7	MODE button	In FM tuner mode, press to turn Stereo mode on or off. In CD or USB mode, press to cycle through Normal , Repeat , and Shuffle play.
8	⏻ (standby/on) button	Press to turn your shelf system on. Press again to put your shelf system in standby mode.
9	MENU button	In iPod® mode, press to return to the previous menu. In tuner mode, press and hold to activate the Auto Programming mode.
10	MUTE button	Press to turn off the sound. Press again to turn the sound back on.
11	▶▶ (next)/Tune ▲ button	In CD, iPod®, or USB mode, press to go to the next track. Hold the button in to fast forward a track. In tuner mode, press to seek the next (higher frequency) radio station.

INSIGNIA™

Insignia NS-ES6113 CD Shelf System with iPod® Dock

#	Button	Description
12	▶ (play/pause)/ MEMORY button	In CD, iPod®, or USB modes, press to begin playback. Press again to pause playback. Press and hold to turn off your iPod®. In tuner mode, press and hold to save a station preset.
13	VOLUME -/+ buttons	Press to decrease (-) or increase (+) the volume.
14	DISPLAY	To display the current time. Press again to resume the original mode display.
15	☀ (backlight)	Press to adjust the display backlight to glow brighter or dimmer in power-on mode.
16	■ STOP	In CD or USB mode, press to stop playback. In iPod® mode, press to pause playback.

Using the remote control

- Aim the remote control at the IR sensor lens on the front of your shelf system from a distance of up to approximately 23 feet (7m) away.
- Make sure that there are no obstacles between the remote control sensor on your shelf system and the remote control.
- Direct sunlight, an incandescent or fluorescent lamp, or any strong light shining on the remote sensor may prevent the sensor from receiving signals from the remote control.

Setting up your shelf system

Installing remote control batteries

To install the remote control batteries:

- 1 Turn the remote control over to the back side.
- 2 Push the release tab to the right and pull the battery tray out of the remote control.

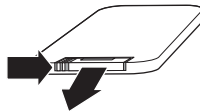

- 3 If this is the first time you will be using the remote control, remove the insulation sheet that covers the battery.
-OR-

If you are replacing the battery, remove the old battery and insert a new lithium coin cell battery (CR2025) into the battery tray. Make sure that you match the + symbol on the battery with the + and symbol on the battery tray.

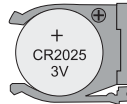

- 4 Slide the battery tray back into the remote control until it clicks into place.

Warnings

- Danger of battery explosion if the battery is incorrectly replaced. Replace only with the same or equivalent type.
- Store the battery in a place where children cannot reach. If a child accidentally swallows the battery, consult a doctor immediately.
- Do not recharge, short, disassemble, or heat the battery, or dispose of it in a fire. Doing any of these things may cause the battery to give off heat, crack, or start a fire.
- Do not leave the battery with other metallic materials. Doing this may cause the battery to give off heat, crack, or start a fire.
- When throwing away or saving the battery, wrap it in tape and insulate; otherwise, the battery may start to give off heat, crack, or start a fire.
- Do not poke the battery with tweezers or similar tools. Doing this may cause the battery to give off heat, crack, or start a fire.
- Dispose of battery in the proper manner, according to federal, state, and local regulations.
- Remove the battery when the charge is depleted.
- Battery chemicals can cause a rash. If the batteries leak, clean the battery compartment with a cloth. If chemicals touch your skin, wash immediately.
- If the remote control is not going to be used for an extended period of time, remove the battery.

Making connections

Connecting the AC adapter

Make sure that the AC power outlet matches the AC adapter's power specifications (100-240 V ~, 50/60 Hz) prior to plugging in the adapter.

Note

For optimum performance, use only the AC adapter provided.

INSIGNIA™ Insignia NS-ES6113 CD Shelf System with iPod® Dock

To connect the AC adapter:

- 1 Complete all other connections.
- 2 Plug the small DC power connector into the DC IN jack on the back of your shelf system.

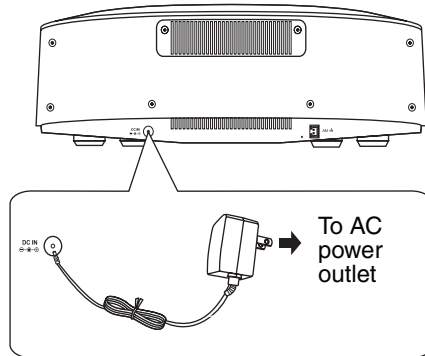

- 3 Plug the AC adapter into an AC power outlet.

Connecting to an external sound source

You can listen to an external device, such as an MP3 player or other auxiliary devices.

To listen to an external sound source:

- 1 Connect the external sound source to the **AUX IN** jack on the top panel of your shelf system using a stereo mini plug cord (not supplied).

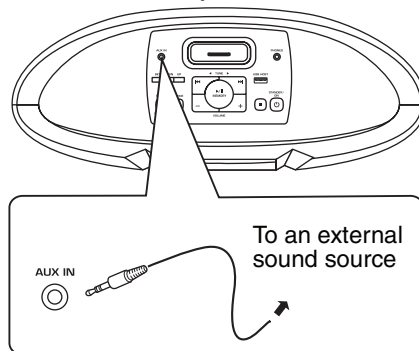

- 2 Press **STANDBY/ON** to turn on your shelf system.
- 3 Turn the volume down.
- 4 Press the **SOURCE** button to select **AUX**.
- 5 Start playback on the external sound source, then adjust the volume to a comfortable level.

Setting the clock

To set the clock:

- 1 Press and hold the **SET** button on the top of your shelf system. The hour format (12 or 24) starts blinking:

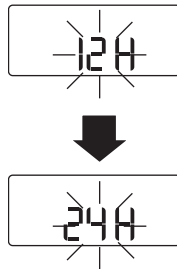

- 2 Press **UP** or **DOWN** to change the format between 12 and 24.
- 3 Press the **SET** button to confirm the setting. The hour setting starts blinking.
- 4 Press **UP** or **DOWN** to change the hour setting, then press the **SET** button to confirm the setting. The minute setting starts blinking.
- 5 Press **UP** or **DOWN** to change the minute setting, then press the **SET** button to confirm the setting.

Using your shelf system

Before using your shelf system, make sure all connections are good, then plug the AC adapter into your shelf system and an AC power outlet.

Turning your shelf system on and off

To turn on your shelf system:

- 1 Press **STANDBY/ON**. Your shelf system turns on and starts playback in the last selected play mode.
- 2 Press **STANDBY/ON** again to switch your shelf system to standby mode.

INSIGNIA™

Insignia NS-ES6113 CD Shelf System with iPod® Dock

Selecting the sound source

To select the sound source:

- Press **SOURCE** repeatedly to cycle through the available sound sources. Options include iPod®, Tuner, USB, AUX, and CD.

Adjusting the volume

To adjust the volume:

- Press **VOLUME +** or **-** to increase or decrease the volume. **VOL** and the current volume setting appear on the display.
- Press **MUTE** to turn off the sound. Press **MUTE** or **VOLUME +** or **-** to turn the sound back on.

Playing a disc

Your shelf system can play audio CD, CD-R, and CD-RW discs, and MP3 and WMA files.

Important

- CDs can only be inserted or ejected in CD mode.
- Do not insert any irregular shape discs (for example, heart or octagonal) or discs with diameter less than 12cm into the disc slot. These discs may damage the system.
- A dirty CD may not play correctly. If a CD does become dirty, wipe it with a soft cloth in a straight line from center to edge.
- The non-DVD side of a "DualDisc" does not comply with the Compact Disc Digital Audio standard, therefore, the non-DVD side of a DualDisc may not play correctly on this product.

To play a disc:

- 1 Turn on your shelf system.
- 2 Press **SOURCE** on the remote control until the CD icon appears on the LCD.

- 3 Insert a disc about halfway into the disc slot, with the label facing up. The system will automatically pull the disc into the player.

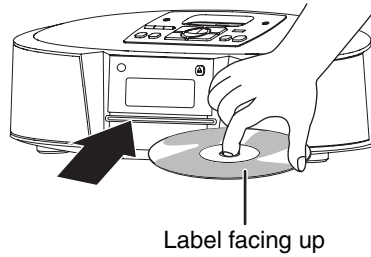

The disc starts playback automatically.

- 4 Press  (eject) to eject the disc.

Controlling disc playback

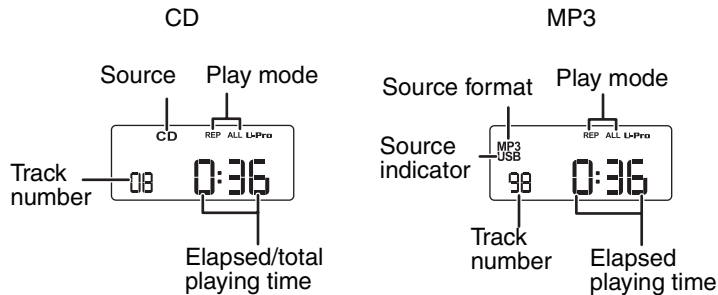

Note: When playing WMA files, the MP3 indicator does not appear.

To control disc playback:

- Press **▶||** (play/pause)/**MEMORY** on the remote control or the shelf system to start or pause playback.
- Press **▶▶|** (next) or **|◀◀** (previous) to go to the next or previous track, or hold to fast forward of fast reverse the playback.
- Press **■ STOP** to stop playback. When playback is resumed, it starts from the beginning of the disc.
- Press **MODE** one or more times to select a repeat mode. You can select:
 - **REP 1**—Repeats the track you are playing
 - **REP ALL**—Repeats the entire disc
 - **SHUF**—Shuffle play the disc
 - blank—Normal mode

INSIGNIA™ Insignia NS-ES6113 CD Shelf System with iPod® Dock

- Press **OK** (in stop mode) to select a specific CD or USB track to play. The first digit of the current track begins to blink. Press **UP** to increase the number, or **DOWN** to decrease the number. Press **OK** again to confirm and start playback.

Playing an iPod®

To listen to an iPod® Shuffle:



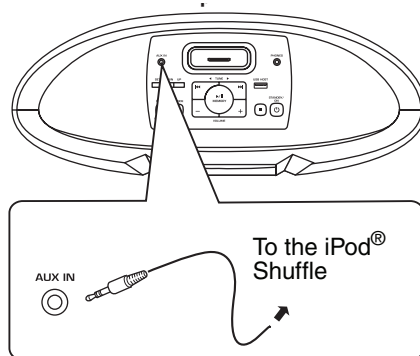



- 1 Connect the iPod® Shuffle to the **AUX IN** jack on the top panel of your shelf system using a stereo mini plug cord (not supplied).



- 2 Press **STANDBY/ON** to turn on your shelf system.
- 3 Turn the volume down.
- 4 Press the **SOURCE** button to select **AUX**.
- 5 Start playback on the iPod® Shuffle, then adjust the volume to a comfortable level.

To connect an iPod®:

- 1 Select the appropriate iPod® dock adapter for your iPod®.

#	iPod® Models Supported	Dock adapter
9	iPod® Classic 80/120GB iPod® (5th generation) 30GB	
10	iPod® Classic 160GB iPod® (5th generation) 60/80GB	
11	iPod® Nano (2nd generation) 2/4/ 8GB	
12	iPhone® 4/8/16GB	
13	iPod® Nano (3rd generation) 4/8GB	
14	iPod® Touch	

Notes

- iPod® dock adapter identification number is marked on the iPod® adapter.
- You can use the supplied dock adapter or your own adapter from Apple Inc.
- We recommend that you buy an appropriate dock adapter in case you lose one.

- 2 Insert the dock adapter as shown in the diagram. The small slot in the dock adapter should be toward the back.

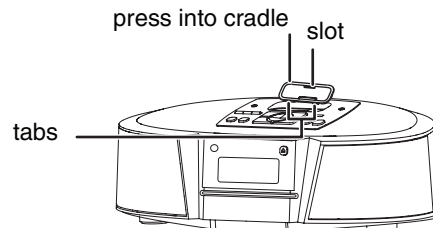

- Match the dock adapter tabs to the front holes in the cradle.
- Press the other side onto the cradle until it clicks into place.
- Remove the iPod® dock adapter with your fingernail by using the slot.

INSIGNIA™ Insignia NS-ES6113 CD Shelf System with iPod® Dock

- 3 Connect your iPod®. Make sure the connector plug is firmly inserted into the connector port of your iPod®.

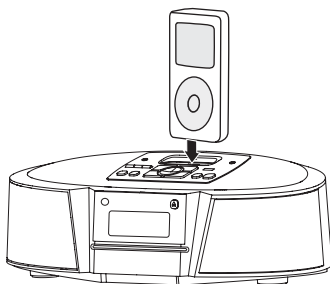

Notes

- Always set volume to the minimum when connecting or disconnecting other equipment.
- When you connect your iPod® to your shelf system, make sure you insert it all the way.

To listen to an iPod®:

- 1 Press **STANDBY/ON** to turn on your shelf system.
- 2 Turn the volume down.
- 3 Press the **SOURCE** button to select **iPod®**. The iPod® automatically starts playback when it is selected.
- 4 Adjust the volume to a comfortable level.

Controlling iPod® playback

You can control iPod® playback just as you control CD playback, by using the **▶||** (play/pause)/**MEMORY** and direction buttons.

To control iPod® playback:

- Press **▶||** (play/pause)/**MEMORY** to start or pause playback. Hold this button to turn the iPod® power off.
- Press **▶▶|** or **|◀◀** to go to the next or previous iPod® track.
- Press and hold **▶▶|** or **|◀◀** to search forward or backward on the iPod®.
- Press **MENU** to jump to the previous iPod® menu.
- Press **^ UP** or **v DOWN** to move up or down one step. (For iPod® Touch or iPhone® the buttons work after starting "Music" or "Videos" by tapping the corresponding application icon on the Home Screen.)
- Press **OK** to confirm the selected item in the menu.
- Press **MODE** to select normal, repeat, or shuffle play.

Charging your iPod®

The iPod® is charged while it is set on your shelf system and your shelf system is powered on.

- Make sure the AC adapter is connected to your shelf system.
- The iPod® is charged regardless of the sound source selected on your shelf system.
- See the iPod® instruction manual about the details of iPod® charging.

Notes

- The connector plug is protected with a cover when it is first purchased. Please remove the cover before operating the shelf system.
- Do not carry the shelf system with your iPod® connected. You might drop it and damage to the connector.
- Do not touch or hit the iPod® terminal pins or the connector pins directly. It might cause damage to the connector part.
- If the iPod® does not play correctly, please update your iPod® software to the latest version. - For details about updating your iPod®, check on the Apple web site: <<http://www.apple.com>>.
- iPod® is a trademark of Apple Inc., registered in the U.S. and other countries.
- We are not responsible for any loss of or damage to your iPod® that might result from the use of this product.
- Sound distortion may occur when playing back audio sources with high recording levels. When distortion occurs, we recommend that you turn off the iPod® equalizer. For information on operating the iPod®, see the iPod® instruction manual.
- The player does not support iPod® 3G (10/20/30/40GB) charging.

Playing a USB device

To play a USB device:

- 1** Plug the USB device into the USB port on the top of your shelf system.
- 2** Press **⏻ STANDBY/ON** to turn on your shelf system.
- 3** Turn on the USB device, if necessary.
- 4** Press the **SOURCE** button to select **USB**. The USB device automatically starts playback when it is selected.

INSIGNIA™ Insignia NS-ES6113 CD Shelf System with iPod® Dock

- 5 Adjust the volume to a comfortable level.

Notes

- This system only supports audio files in MP3 and WMA formats.
- Make sure the USB music device is not locked by its Hold button during playback.
- This system does not play MP3 players with a security function.

Playing from an external device

To play from an external device:

- 1 Make sure that an external device is connected to your shelf system. For more information, see “Connecting to an external sound source” on page 14.
- 2 Turn on your shelf system, then press **AUX**. Sound from the device plays through your shelf system’s speakers.

Playing the radio

Note

Position the FM antenna or AM loop antenna as far as possible from the AC adapter, TV, or other radiation source.

To play the radio:

- 1 Turn on your shelf system, then press **SOURCE** to select either **AM** or **FM**.
- 2 If you are listening to FM, stretch out the FM antenna on the back of your shelf system and move it around to improve reception.
-OR-
If you are listening to AM, connect the AM loop antenna to the back of your shelf system.
- 3 Press **▶▶** or **◀◀** to tune the radio to a higher or lower frequency one step at a time. Hold for more than one second to activate the Auto Seek function, which tunes the radio up or down until a station is found. Press again to quit seeking.
- 4 Press **^ UP** or **v DOWN** to select the next or previous preset station.
- 5 If you are listening to an FM station and the reception is poor, press **MODE** to turn off stereo mode and turn off U-Pro mode, which can reduce noise and interference.
- 6 Adjust the volume to a comfortable level.

Storing radio station presets

Your shelf system can store 10 AM and 20 FM station presets.

To store radio station presets manually:

- 1 Turn on your shelf system, then press **SOURCE** to select either **AM** or **FM**.
- 2 Tune to the frequency you want to save by one of the following methods:
 - Press **▶▶|** or **|◀◀** to tune the radio to a higher or lower frequency one step at a time.
 - Hold **▶▶|** or **|◀◀** for more than one second to activate the Auto Seek function, which tunes the radio up or down until a station is found.
- 3 Press and hold **▶||** (play/pause)/**MEMORY** to save the station as a preset. The channel (preset) number starts blinking in the lower left corner of the display.
- 4 Press **^ UP** or **v DOWN** to select the channel (preset) number you want to use.
- 5 Press **▶||** (play/pause)/**MEMORY** again, while the number is blinking, to save the selected frequency to that preset.

To store radio station presets automatically:

- 1 Turn on your shelf system, then press **SOURCE** to select either **AM** or **FM**.
- 2 Press and hold the **MENU** button. The shelf system automatically scans the frequency band and saves the first 10 AM stations (in AM tuner mode) or the first 20 FM stations (in FM tuner mode) it finds as presets. The shelf system then returns to the first station found.
- 3 Press **MENU** again quit autoprogramming.

Activating the U-Pro® sound effect



U-Pro® and the U-Pro® symbol are registered trademarks of the Beautiful Enterprise Co., Ltd.

"U-Pro" is an in-house technology developed by the Beautiful Enterprise Company Limited, designed specifically for an ultra-wide sound field for all digital music systems. With exceptionally life-like and natural sound reproduction of high definition and fidelity, this portable audio system can provide you with superior personal entertainment in listening to "High Definition Wide Stereo."

Press the **U-Pro** button to activate the sound effect. The "U-Pro" mark is displayed. U-Pro is not applicable in AM Tuner or headphone mode.

INSIGNIA™

Insignia NS-ES6113 CD Shelf System with iPod® Dock

Troubleshooting

Problem	Cause/Solution
No power	<ul style="list-style-type: none"> Make sure that the AC power adapter is fully inserted into the AC power outlet.
The remote control does not work	<ul style="list-style-type: none"> The batteries may be dead. Change the batteries. The remote control is not aimed at the remote control sensor on the shelf system. Aim the remote control directly at the shelf system when you push the buttons.
Cannot connect an iPod®	<ul style="list-style-type: none"> Make sure that the dock adapter you selected is compatible with your iPod®. Make sure that the dock adapter is correctly mounted on the shelf system.
Cannot play an iPod®	<ul style="list-style-type: none"> Make sure that the iPod® is firmly inserted into the iPod® connector on your shelf system. Make sure that the iPod® is working. Test it before trying to connect it to the shelf system.
Cannot charge an iPod®	<ul style="list-style-type: none"> Make sure that the iPod® is firmly inserted into the iPod® connector on your shelf system. Make sure that the AC adapter is plugged in and firmly connected to the DC IN port on your shelf system.
CD does not play	<ul style="list-style-type: none"> Make sure that the disc is inserted correctly. Make sure that the disc is not dirty or defective. If moisture or condensation has accumulated inside your shelf system, let your shelf system warm up for 60 minutes so the liquid evaporates. The disc may not be compatible with your shelf system.
No sound from the speakers	<ul style="list-style-type: none"> Make sure that the volume level is set correctly. Make sure that the sound is not muted.
The system does not respond when buttons are pressed	<ul style="list-style-type: none"> Remove and reconnect the AC power plug and switch on the system again.
Static or noise when playing the radio	<ul style="list-style-type: none"> Make sure that the station is tuned correctly and that the station has a good signal. Try another station. If you are playing an AM station, rotate the antenna to improve the reception. If you are playing an FM station, extend the antenna wire to improve the reception.
The shelf system does not recognize a USB device	<ul style="list-style-type: none"> Remove and reconnect the USB device in USB mode. Make sure that the USB device is firmly connected to the shelf system. Make sure that the shelf system is set to USB mode. Make sure that the USB device is not locked by its HOLD button.

Maintaining

Cleaning discs

A dirty disc may not play correctly.

To clean a disc:

- With a soft cloth, wipe the disc in a straight line from the center to the edge.

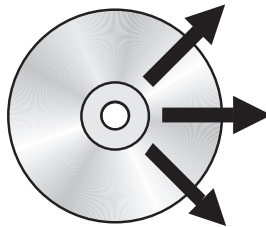

Caution

Do not use any solvent, such as record spray, thinner, or benzene, to clean a disc.

Cleaning your shelf system

To clean your shelf system, follow these guidelines:

- Use a soft, clean cloth moistened with plain, luke-warm water to clean the exterior of your shelf system.
- Do not let liquid drip into the inside of your shelf system.
- For stubborn stains, use a soft cloth dampened with a weak solution of mild detergent and water. Dry your shelf system immediately afterwards with a clean cloth. Do not use abrasive clothes, thinners, alcohol, or other chemical solvents, because they may damage the finish or remove the panel lettering.

Specifications

Specifications are subject to change without notice.

Type	iPod® CD USB Shelf System
Amplifier	Power output - 15 W + 15 W
Input sensitivity	AUX input - 300 to 400 mV

INSIGNIA™

Insignia NS-ES6113 CD Shelf System with iPod® Dock

Tuner	Bands: FM and AM Range: FM - 87.5~107.9 MHz AM - 530~1710 KHz Freq step: FM - 200 KHz AM - 10 KHz Presets: FM - 20 AM - 10
Speaker	6 ohm
Input terminals	External DC IN (for AC adapter), AUX IN
Power source	DC (External DC IN) from AC adapter
AC adapter	Input: 100-240V~, 50/60 Hz Output: 14 V, 3 A DC
Dimensions	15.98 x 6.44 x 5.51 in (40.6 x 16.4 x 14.0 cm)
Weight	6.62 lb (3 kg)

Legal notices

FCC Part 15

This device complies with Part 15 of the FCC Rules. Operation of this product is subject to the following two conditions: (1) this device may not cause harmful interference, and (2) this device must accept any interference received, including interference that may cause undesired operation.

This equipment has been tested and found to comply within the limits for a class B digital device, pursuant to Part 15 of the FCC Rules. These limits are designed to provide reasonable protection against harmful interference in a residential installation. This equipment generates, uses, and can radiate radio frequency energy and, if not installed and used in accordance with the instructions, may cause harmful interference to radio communications. However, there is no guarantee that interference will not occur in a particular installation. If this equipment does cause harmful interference to radio or television reception, which can be determined by turning the equipment off and on, the user is encouraged to try to correct the interference by one or more of the following measures:

- Reorient or relocate the receiving antenna.
- Increase the separation between the equipment and receiver.
- Connect the equipment into an outlet on a circuit different from that to which the receiver is connected.
- Consult the dealer or an experienced technician for help.

FCC warning

Changes or modifications not expressly approved by the party responsible for compliance with the FCC Rules could void the user's authority to operate this equipment.

Energy Star

Products that have earned ENERGY STAR® are designed to protect the environment through superior energy efficiency. Your player is Energy Star compliant.



One-year limited warranty

Insignia Products ("Insignia") warrants to you, the original purchaser of this new **NS-ES6113** ("Product"), that the Product shall be free of defects in the original manufacture of the material or workmanship for a period of one (1) year from the date of your purchase of the Product ("Warranty Period"). This Product must be purchased from an authorized dealer of Insignia brand products and packaged with this warranty statement. This warranty does not cover refurbished Product. If you notify Insignia during the Warranty Period of a defect covered by this warranty that requires service, terms of this warranty apply.

How long does the coverage last?

The Warranty Period lasts for 1 year (365 days) from the date you purchased the Product. The purchase date is printed on the receipt you received with the Product.

What does this warranty cover?

During the Warranty Period, if the original manufacture of the material or workmanship of the Product is determined to be defective by an authorized Insignia repair center or store personnel, Insignia will (at its sole option): (1) repair the Product with new or rebuilt parts; or (2) replace the Product at no charge with new or rebuilt comparable products or parts. Products and parts replaced under this warranty become the property of Insignia and are not returned to you. If service of Products or parts are required after the Warranty Period expires, you must pay all labor and parts charges. This warranty lasts as long as you own your Insignia Product during the Warranty Period. Warranty coverage terminates if you sell or otherwise transfer the Product.

How to obtain warranty service?

If you purchased the Product at a retail store location, take your original receipt and the Product to the store you purchased it from. Make sure that you place the Product in its original packaging or packaging that provides the same amount of protection as the original packaging. If you purchased the Product from an online web site, mail your original receipt and the Product to the address listed on the web site. Make sure that you put the Product in its original packaging or packaging that provides the same amount of protection as the original packaging.

To obtain in-home warranty service for a television with a screen 25 inches or larger, call 1-888-BESTBUY. Call agents will diagnose and correct the issue over the phone or will have an Insignia-approved repair person dispatched to your home.

Where is the warranty valid?

This warranty is valid only to the original purchaser of the product in the United States, Canada, and Mexico.

What does the warranty not cover?

This warranty does not cover:

- Customer instruction
- Installation
- Set up adjustments
- Cosmetic damage
- Damage due to acts of God, such as lightning strikes
- Accident
- Misuse
- Abuse
- Negligence
- Commercial use

INSIGNIA™ Insignia NS-ES6113 CD Shelf System with iPod® Dock

- Modification of any part of the Product, including the antenna
- Plasma display panel damaged by static (non-moving) images applied for lengthy periods (burn-in).

This warranty also does not cover:

- Damage due to incorrect operation or maintenance
- Connection to an incorrect voltage supply
- Attempted repair by anyone other than a facility authorized by Insignia to service the Product
- Products sold as is or with all faults
- Consumables, such as fuses or batteries
- Products where the factory applied serial number has been altered or removed

REPAIR REPLACEMENT AS PROVIDED UNDER THIS WARRANTY IS YOUR EXCLUSIVE REMEDY. INSIGNIA SHALL NOT BE LIABLE FOR ANY INCIDENTAL OR CONSEQUENTIAL DAMAGES FOR THE BREACH OF ANY EXPRESS OR IMPLIED WARRANTY ON THIS PRODUCT, INCLUDING, BUT NOT LIMITED TO, LOST DATA, LOSS OF USE OF YOUR PRODUCT, LOST BUSINESS OR LOST PROFITS. INSIGNIA PRODUCTS MAKES NO OTHER EXPRESS WARRANTIES WITH RESPECT TO THE PRODUCT, ALL EXPRESS AND IMPLIED WARRANTIES FOR THE PRODUCT, INCLUDING, BUT NOT LIMITED TO, ANY IMPLIED WARRANTIES OF AND CONDITIONS OF MERCHANTABILITY AND FITNESS FOR A PARTICULAR PURPOSE, ARE LIMITED IN DURATION TO THE WARRANTY PERIOD SET FORTH ABOVE AND NO WARRANTIES, WHETHER EXPRESS OR IMPLIED, WILL APPLY AFTER THE WARRANTY PERIOD. SOME STATES, PROVINCES AND JURISDICTIONS DO NOT ALLOW LIMITATIONS ON HOW LONG AN IMPLIED WARRANTY LASTS, SO THE ABOVE LIMITATION MAY NOT APPLY TO YOU. THIS WARRANTY GIVES YOU SPECIFIC LEGAL RIGHTS, AND YOU MAY ALSO HAVE OTHER RIGHTS, WHICH VARY FROM STATE TO STATE OR PROVINCE TO PROVINCE.

Contact Insignia:

For customer service please call 1-877-467-4289
www.insigniaproducts.com

Distributed by Best Buy Purchasing, LLC
7601 Penn Avenue South, Richfield, Minnesota, U.S.A. 55423-3645
© 2009 Best Buy Enterprise Services, Inc.

All rights reserved. INSIGNIA is a trademark of Best Buy Enterprise Services, Inc.
Registered in some countries. All other products and brand names are trademarks of their respective owners.

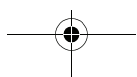
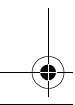
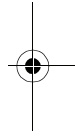
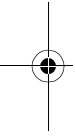
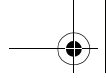

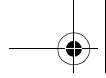

INSIGNIA™ Insignia NS-ES6113 CD Shelf System with iPod® Dock

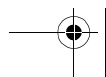
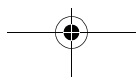
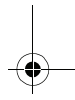
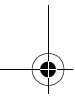
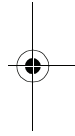
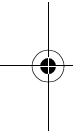

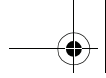

Insignia NS-ES6113 CD Shelf System with iPod® Dock

INSIGNIA™

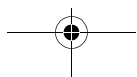
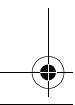
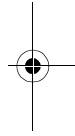
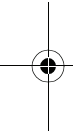

INSIGNIA™

www.insigniaproducts.com (877) 467-4289

Distributed by Best Buy Purchasing, LLC
7601 Penn Avenue South, Richfield, MN USA 55423-3645
© 2009 Best Buy Enterprise Services, Inc.

All rights reserved. INSIGNIA is a trademark of Best Buy Enterprise Services, Inc. Registered in some countries.
All other products and brand names are trademarks of their respective owners.

ENGLISH
09-0084